



- Bordeaux **RAL 3004**
- Bianco **RAL 9010**
- Nero **RAL 9005**
- Beige **RAL 1015**

DATI TECNICI

Potenza termica globale (max. - min.)	14,5 - 4,2 kW	Emissioni OGC (13% O ₂) (max. - min.)	1,4 - 3 mg/m³
Potenza nominale (max. - min.)	13,8 - 4,1 kW	Emissioni polveri (13% O ₂) (max. - min.)	13,6 - 27,5 mg/m³
Potenza resa all'acqua (max. - min.)	10,5 - 2,8 kW	Massa fumi (max. - min.)	7,1 - 3,5 g/s
Potenza indiretta (max. - min.)	3,3 - 1,3 kW	Depressione canna fumaria (max. - min.)	11,9 - 9,9 Pa
Rendimento (max. - min.)	95,1 - 97,4 %	Peso	170 kg
Temperatura dei fumi (max. - min.)	103,2 - 43,1 °C	Dimensioni LxPxH	576x572x1012 mm
Capacità serbatoio pellet	25 kg	Dimensione uscita fumi	ø 80 mm
Capacità caldaia	35 lt	Uscita fumi	Posteriore
Consumo orario (max. - min.)	3 - 0,9 kg/h		
Volume riscaldabile (indicativo)	320 m³		
Autonomia (max. - min.)	8,33 - 27,7 h		
Emissioni CO (13% O ₂) (max. - min.)	35 - 192 mg/m³		
Emissioni NOx (13% O ₂) (max. - min.)	141 - 125 mg/m³		

DOTAZIONI

- Sonda temperatura acqua
- Contenitore cenere estraibile
- Collegamento termostato esterno
- Cronotermostato settimanale
- Braciere in acciaio Inox
- Camera stagna
- Regolazione su livelli di potenza modulanti
- Kit idraulico
- Autoregolazione dosaggio pellet
- Collegamento all'impianto di riscaldamento

OPTIONAL

- Telecomando
- WI FI
- Ventilatore aria

DIMENSIONI ED INGOMBRI

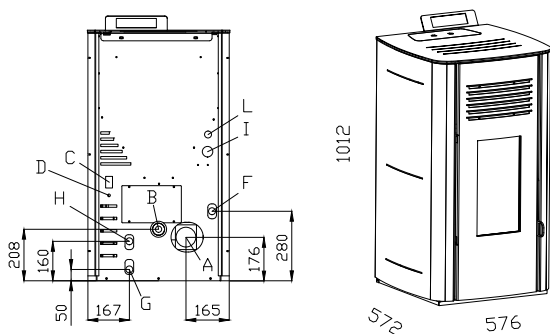

- A** Scarico fumi ø 80 mm
- B** Aspirazione aria ø 60 mm
- C** Interruttore on/off
- D** Termostato a riarmo manuale
- F** Mandata ø ¾ M
- G** Ritorno ø ¾ M
- H** Scarico valvola sicurezza ø ½
- I** Idrometro
- L** Dimmer regolazione ventilazione (versione ventilata)

CERTIFICAZIONI

EN 14785:2006	German BIMSchv	Flamme Verte (7 stars)
Austrian 15a B-VG	Swiss TRV Limits	

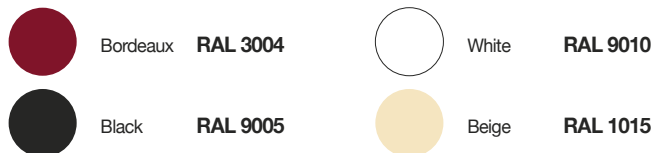

TECHNICAL DATA

Total heat input (max. - min.)	14,5 - 4,2 kW	Emissions OGC (13% O ₂) (max. - min.)	1,4 - 3 mg/m³
Nominal heat output (max. - min.)	13,8 - 4,1 kW	Dust emissions (13% O ₂) (max. - min.)	13,6 - 27,5 mg/m³
Water useful power (max. - min.)	10,5 - 2,8 kW	Flue gas mass flow (max. - min.)	7,1 - 3,5 g/s
Indirect power (max. - min.)	3,3 - 1,3 kW	Average flue draught (max. - min.)	11,9 - 9,9 Pa
Efficiency (max. - min.)	95,1 - 97,4 %	Weight	170 kg
Flue gas temperature (max. - min.)	103,2 - 43,1 °C	Dimensions LxPxH	576x572x1012 mm
Hopper capacity	25 kg	Smoke outlet dimensions	ø 80 mm
Boiler capacity	35 lt	Smoke outlet	Rear exhaust
Hourly consumption (max. - min.)	3 - 0,9 kg/h		
Heating volume	320 m³		
Autonomy (max. - min.)	8,33 - 27,7 h		
Emissions CO (13% O ₂) (max. - min.)	35 - 192 mg/m³		
Emissions NOx (13% O ₂) (max. - min.)	141 - 125 mg/m³		

DEVICES

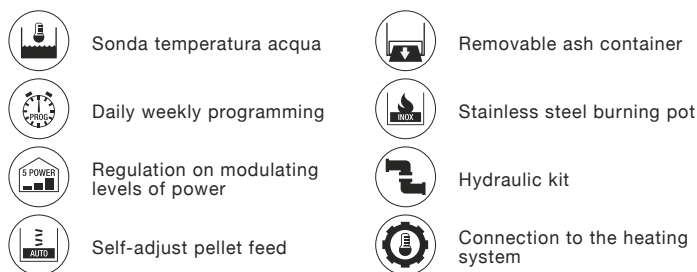

OPTIONAL

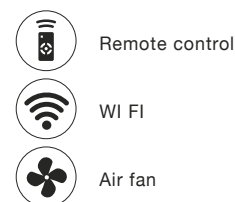

DIMENSIONS

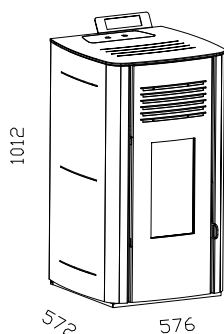
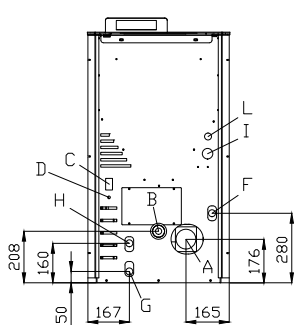

A Smoke outlet ø 80 mm	H Safety drain ø ½
B External air inlet ø 60 mm	I Hydrometer
C Electric socket	L Ventilation adjustment dimmer (version with fan)
D Manual reset thermostat	
F Boiler flow outlet ø ¾ M	
G Boiler return ø ¾ M	

CERTIFICATIONS

EN 14785:2006	German BIMSChv	Flamme Verte (7 stars)
Austrian 15a B-VG	Swiss TRV Limits	

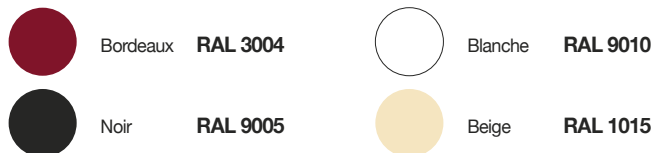

DONNÉES TECHNIQUES

Puissance thermique globale (max. - min.)	14,5 - 4,2 kW	Emissions OGC (13% O ₂) (max. - min.)	1,4 - 3 mg/m³
Puissance thermique nominale(max. - min.)	13,8 - 4,1 kW	Emissions poussières (13% O ₂) (max. - min.)	13,6 - 27,5 mg/m³
Puissance utile à l'eau (max. - min.)	10,5 - 2,8 kW	Débit de fumées (max. - min.)	7,1 - 3,5 g/s
Potenza indiretta (max. - min.)	3,3 - 1,3 kW	Dépression cheminée (max. - min.)	11,9 - 9,9 Pa
Rendement (max. - min.)	95,1 - 97,4 %	Poids	170 kg
Température des fumées (max. - min.)	103,2 - 43,1 °C	Dimensions LxPxH	576x572x1012 mm
Capacité réservoir	25 kg	Sortie de fumée	ø 80 mm
Capacité de la chaudière	35 lt	Sortie de fumée	Sortie postérieure
Consommation horaire (max. - min.)	3 - 0,9 kg/h		
Capacité de chauffe	320 m³		
Autonomie (max. - min.)	8,33 - 27,7 h		
Emissions CO (13% O ₂) (max. - min.)	35 - 192 mg/m³		
Emissions NOx (13% O ₂) (max. - min.)	141 - 125 mg/m³		

EQUIPEMENT



OPTIONAL

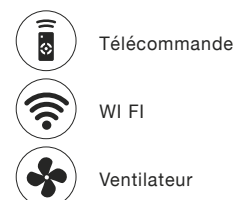

DIMENSIONS

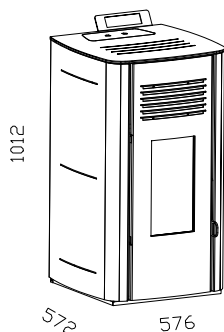
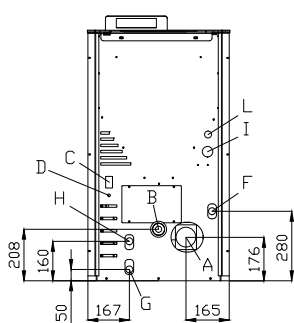

A Évacuation fumées ø 80 mm	H Décharge sécurité ø 1/2
B Prise d'aire comburant ø 60 mm	I Hydromètre
C Interrupteur	L Gradateur de réglage de la ventilation (ventilateur version)
D Thermostat à réarmement manuel	
F Départ chaudière ø 3/4 M	
G Retour chaudière ø 3/4 M	

CERTIFICATIONS

EN 14785:2006

German BIMSchv

Flamme Verte (7 stars)

Austrian 15a B-VG

Swiss TRV Limits

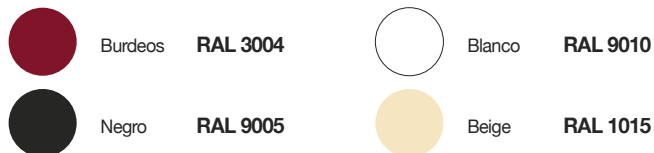

DATOS TÉCNICOS

Potencia térmica total (max. - min.)	14,5 - 4,2 kW	Emisiones OGC (13% O ₂) (max. - min.)	1,4 - 3 mg/m³
Potencia térmica nominal (max. - min.)	13,8 - 4,1 kW	Emisiones polvo (13% O ₂) (max. - min.)	13,6 - 27,5 mg/m³
Potencia al agua (max. - min.)	10,5 - 2,8 kW	Masa de humos (max. - min.)	7,1 - 3,5 g/s
Potencia indirecta (max. - min.)	3,3 - 1,3 kW	Tiro de la chimenea (max. - min.)	11,9 - 9,9 Pa
Rendimiento (max. - min.)	95,1 - 97,4 %	Peso	170 kg
Temperatura de los humos (max. - min.)	103,2 - 43,1 °C	Dimensiones LxPxH	576x572x1012 mm
Capacidad depósito de pellets	25 kg	Dimensiones salida humos	ø 80 mm
Capacidad de la caldera	35 lt	Salida humos	Salida posterior
Consumo horario (max. - min.)	3 - 0,9 kg/h		
Volumen de calentamiento	320 m³		
Autonomía (max. - min.)	8,33 - 27,7 h		
Emisiones CO (13% O ₂) (max. - min.)	35 - 192 mg/m³		
Emisiones NOx (13% O ₂) (max. - min.)	141 - 125 mg/m³		

EQUIPAMIENTO



OPTIONAL



DIMENSIONES

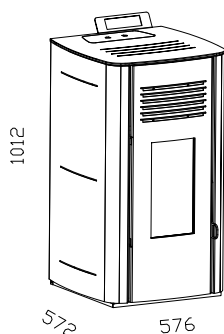
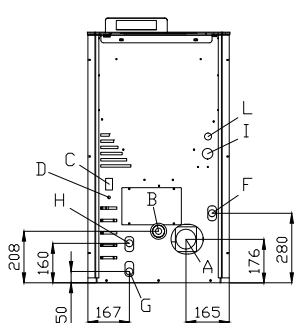

A	Salida de humos ø 80 mm	H	Descarga de seguridad ø 1/2
B	Aspiración de aire ø 60 mm	I	Hidrómetro
C	Interruptor	L	Regulación de la ventilación
D	Termostato a rearme manual		
F	Ida/salida de la caldera ø 3/4 M		
G	Retorno de la caldera ø 3/4 M		

CERTIFICACIONES

EN 14785:2006

German BIMSChv

Flamme Verte (7 stars)

Austrian 15a B-VG

Swiss TRV Limits

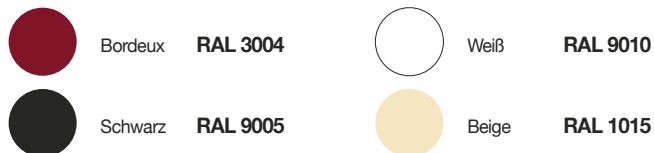

TECHNISCHE DATEN

Brennstoffwärmeleistun (max. - min.)	14,5 - 4,2 kW	Emissionen OGC (13% O ₂) (max. - min.)	1,4 - 3 mg/m³
Nennwärmeleistung (max. - min.)	13,8 - 4,1 kW	Feinstaubsinhalt (13% O ₂) (max. - min.)	13,6 - 27,5 mg/m³
Nennwärmeleistung Wasseranteil (max. - min.)	10,5 - 2,8 kW	Abgasmassenstrom (max. - min.)	7,1 - 3,5 g/s
Indirekte Leistung (max. - min.)	3,3 - 1,3 kW	Mindestförderdruck (max. - min.)	11,9 - 9,9 Pa
Wirkungsgrad (max. - min.)	95,1 - 97,4 %	Gewicht	170 kg
Abgastemperatur (max. - min.)	103,2 - 43,1 °C	Bemaßung LxPxH	576x572x1012 mm
Inhalt Pelletbehälter	25 kg	Rauchabzug	ø 80 mm
Wasserbehälter	35 lt	Rauchabzug	Abgasstutzen Hinten
Stundenverbrauch (max. - min.)	3 - 0,9 kg/h		
Raumheizvermöge	320 m³		
Betriebsautonomie (max. - min.)	8,33 - 27,7 h		
Emissionen CO (13% O ₂) (max. - min.)	35 - 192 mg/m³		
Emissionen NOx (13% O ₂) (max. - min.)	141 - 125 mg/m³		

AUSRÜSTUNG



OPTIONAL



GRÖSSE

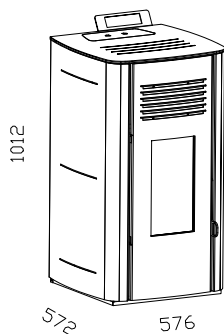
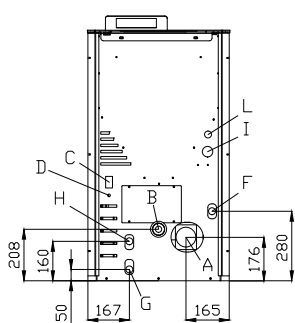

A Rauchabzug ø 80 mm	H Sicherheitsauslass ø 1/2
B Öffnungen für die Verbrennungsluft ø 60 mm	I Hydrometer
C Hauptschalter	L Lüftungseinstelldimmer
D Manueller Thermostat zurücksetzen	
F Kessel-volauf ausgang ø 3/4 M	
G Kessel-rücklauf/ingang ø 3/4 M	

ZERTIFIZIERUNGEN

EN 14785:2006	German BIMSchv	Flamme Verte (7 stars)
Austrian 15a B-VG	Swiss TRV Limits	

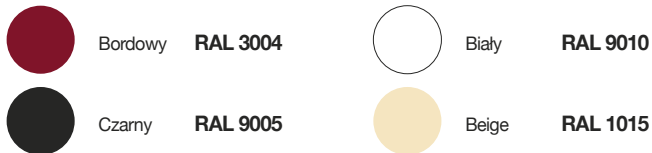

DANE TECHNICZNE

Wprowadzona moc cieplna (max. - min.)	14,5 - 4,2 kW	Emisja OGC (13% O ₂) (max. - min.)	1,4 - 3 mg/m³
Moc grzewcza całkowita (max. - min.)	13,8 - 4,1 kW	Emisja pyłu (13% O ₂) (max. - min.)	13,6 - 27,5 mg/m³
Moc cieplna przekazana (max. - min.)	10,5 - 2,8 kW	Masowy przepływ oparów (max. - min.)	7,1 - 3,5 g/s
Moc pośrednia (max. - min.)	3,3 - 1,3 kW	Ciąg kominowy (max. - min.)	11,9 - 9,9 Pa
Sprawność (max. - min.)	95,1 - 97,4 %	Waga	170 kg
Średnia temperatura spalin (max. - min.)	103,2 - 43,1 °C	Wymiary LxPxH	576x572x1012 mm
Pojemność zbiornika	25 kg	Ujście dymu	ø 80 mm
Pojemność kotła	35 lt	Ujście dymu	Wylot spalin tylny
Zużycie paliwa moc (max. - min.)	3 - 0,9 kg/h		
Objętość ogrzewalna (indicativo)	320 m³		
Autonomia pracy (max. - min.)	8,33 - 27,7 h		
Emisja CO (13% O ₂) (max. - min.)	35 - 192 mg/m³		
Emisja NOx (13% O ₂) (max. - min.)	141 - 125 mg/m³		

EQUIPAMIENTO



OPTIONAL

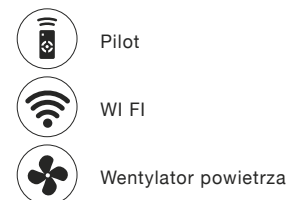

WYMIARY

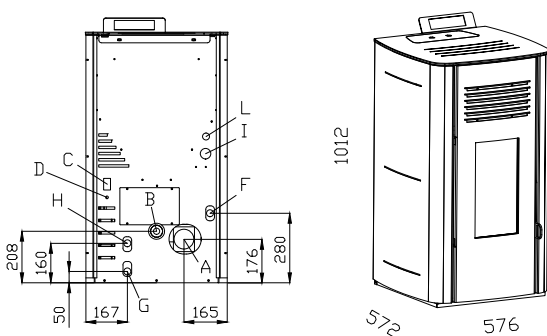

A	Ujście dymu ø 80 mm	H	Spust zaworu bezpieczeństwa ø ½
B	Chwył powietrza do spalania ø 60 mm	I	Aerometr
C	Wyłącznikiem	L	Ściemniacz regulacji wentylacji
D	Termostat z ręcznym resetem		
F	Rury dostawy ø ¾ M		
G	Rury zwrotu ø ¾ M		

CERTYFIKATY

EN 14785:2006	German BIMSChv	Flamme Verte (7 stars)
Austrian 15a B-VG	Swiss TRV Limits	